

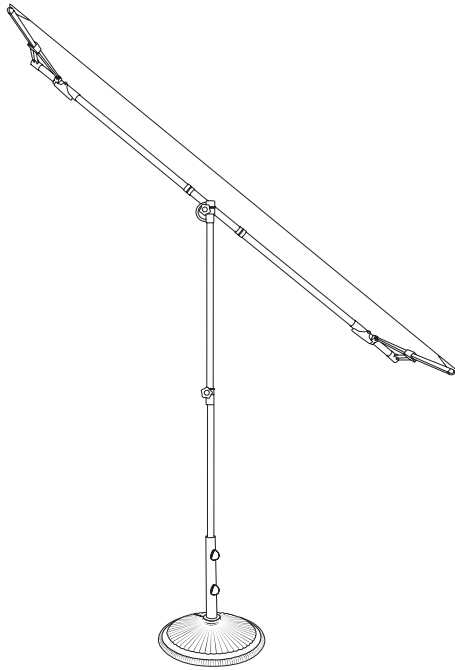

SimplyShade®

Capri *Balcony Umbrella*

4.95' x 6.93' Rectangle / SSBU-5X7RT5T



Instruction Manual

Thank you for purchasing SimplyShade's Capri Balcony Umbrella.

Please remove all contents from the package, inspect and review checklist.

CAUTION: To reduce personal injury and damage to your umbrella, read and follow this assembly and operation guide. We recommend a two-person team for assembly and disassembly. *Save information for future reference.*

CAPRI CHECKLIST

- | | | |
|-------------------|---------------------|-------------------------------------|
| A - Canopy | E- Middle Strut | I - Bottom Pole |
| B - Stopper Rings | F- Joint Knob | J - Reducer |
| C - Slider Car | G- Top Pole | K - Base (sold separately) |
| D - Strut | H- Bottom Pole Knob | L - Protective Cover
(not shown) |

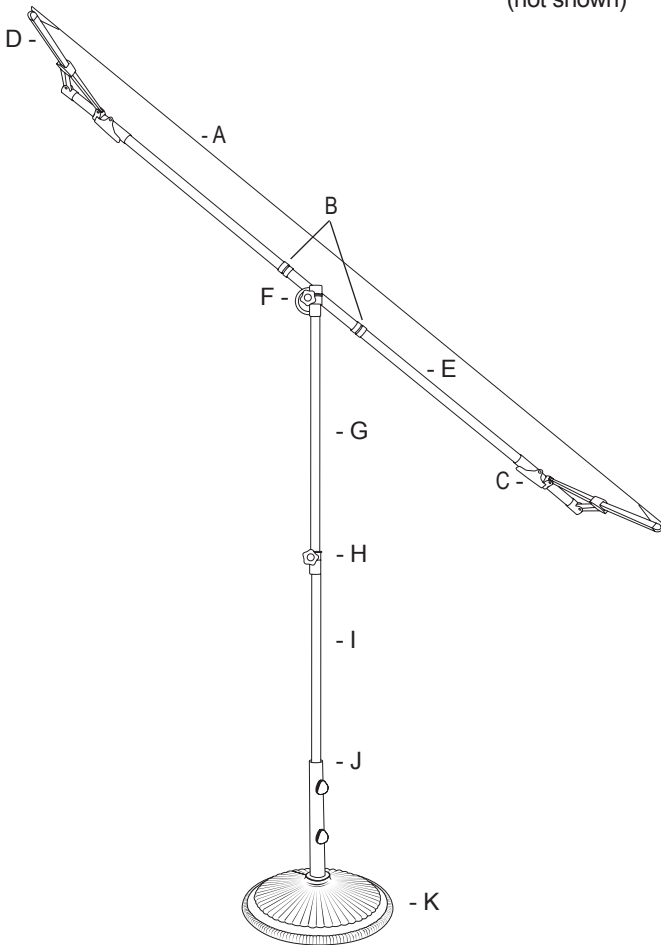

IMPORTANT:

It is imperative to use appropriate base weight for your size umbrella. The minimum base weight recommended for the Capri is 50lbs.

STEP 1 Set Up

Carefully remove umbrella parts from box and lay on a soft clean surface.

Insert reducer into stem of base (sold separately). Insert bottom pole into base stem (Fig. 1) and tighten base stem knobs to secure umbrella in place. Assemble bottom pole knob to bottom pole with small locking screw and washer (Fig. 2). Turn bottom pole knob clockwise to tighten.

From canopy structure, untie middle canopy tie. Assemble top pole to middle strut by inserting large locking screw into joint mechanism and tighten with washer and joint knob (Fig. 3).

Lift assembled top pole and insert into bottom pole (Fig. 4). NOTE: Loosen bottom pole knob by turning counter clockwise if top pole does not easily slide into bottom pole.

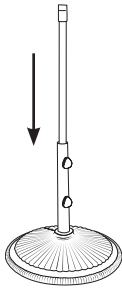

(Fig. 1)

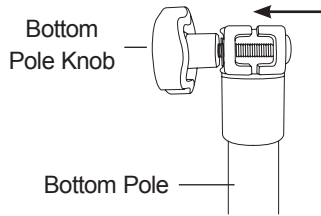

(Fig. 2)

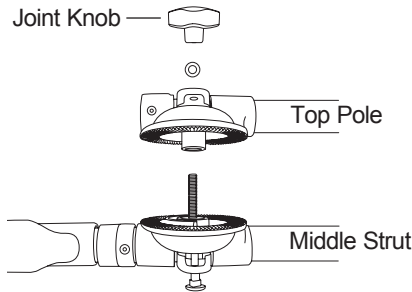

(Fig. 3)

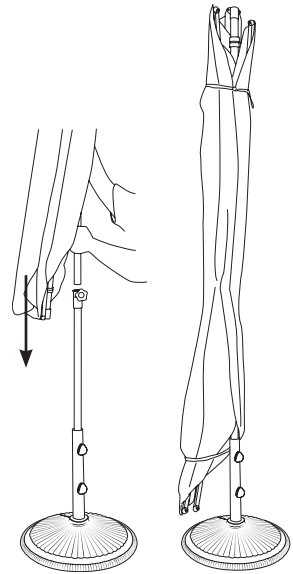
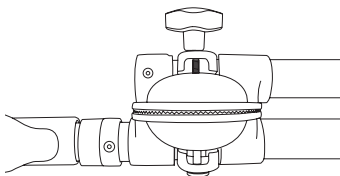

(Fig. 4)

STEP 2 Open Umbrella

Untie remaining canopy ties to free canopy. Loosen bottom pole knob by turning counter clockwise (Fig. 5). With one hand on the bottom pole and a second hand on the middle strut, pull upward to extend top pole (Fig. 6). Once desired height is reached, tighten bottom pole knob by turning clockwise to secure in place (Fig. 7).

IMPORTANT: Do not extend top pole past warning label located on top pole approximately 26" down from top, 10" from bottom. Pulling top pole past warning label will detach top pole from the bottom pole. If this occurs, simply insert top pole back into bottom pole.

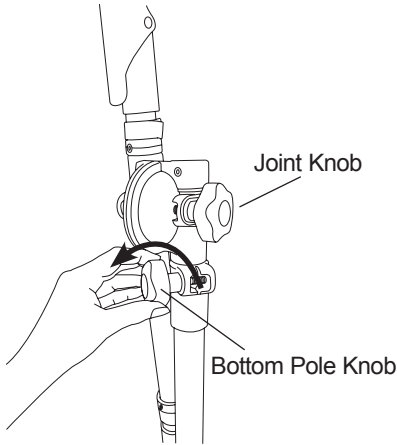

(Fig. 5)

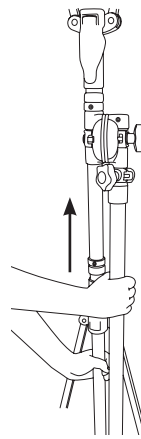

(Fig. 6)

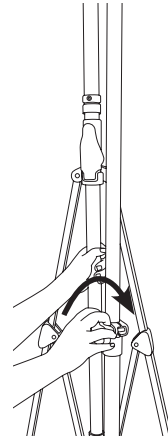

(Fig. 7)

Loosen joint knob by turning counter clockwise (Fig. 8). Level canopy to a horizontal position and turn slider cars downward (Fig. 9). Turn joint knob clockwise to secure in place. Extend slider cars outward, one at a time, until they snap in place (Fig. 10).

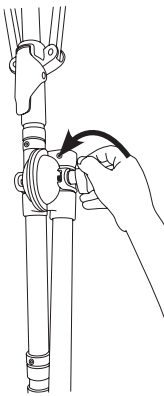

(Fig. 8)

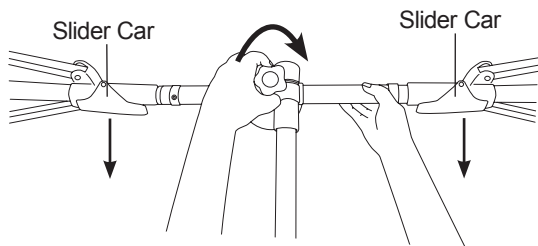

(Fig. 9)

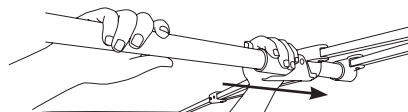

(Fig. 10)

STEP 3 Positioning Canopy

To position canopy, loosen joint knob by turning counter clockwise and slide middle strut between stopper rings for desired shade position (Fig. 11). Turn joint knob clockwise to secure in place.

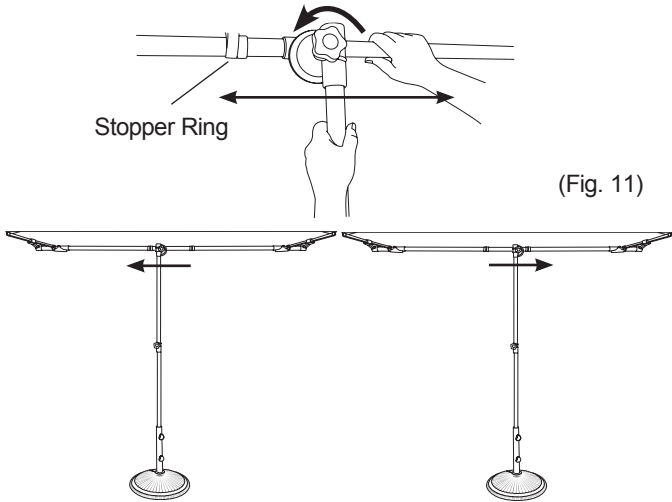

STEP 4 Tilt Umbrella

To tilt canopy, loosen joint knob by turning counter clockwise and tilt canopy left to right (Fig. 12). Turn joint knob clockwise to secure tilt position in place. To rotate canopy, loosen joint knob by turning counter clockwise and rotate canopy front to back (Fig. 13). Turn joint knob clockwise to secure canopy in place.

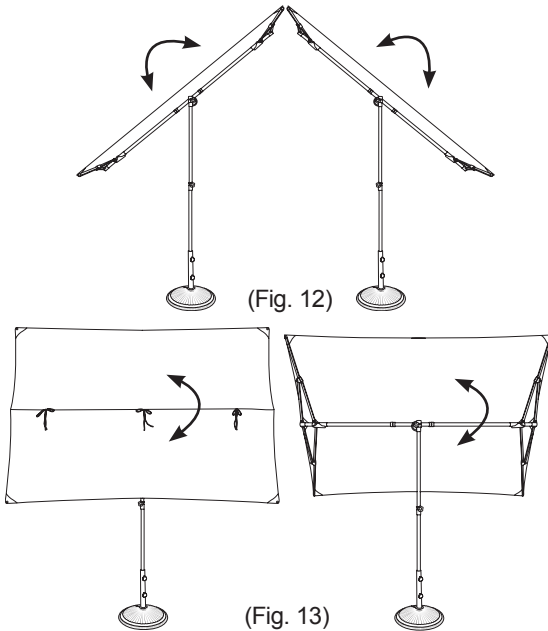

STEP 5 Close Umbrella

To close canopy, loosen joint knob by turning counter clockwise and bring canopy to a horizontal position (Fig. 14). Turn joint knob clockwise to secure in place. One at a time, press slider car handle to disengage (Fig. 15). Slide slider cars one at a time, inward until canopy is fully closed.

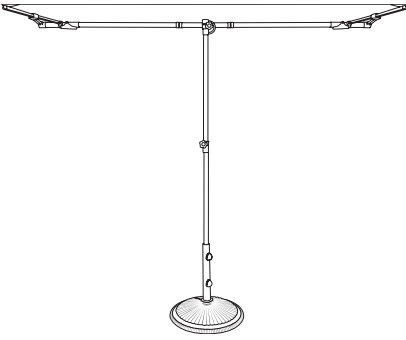

(Fig. 14)

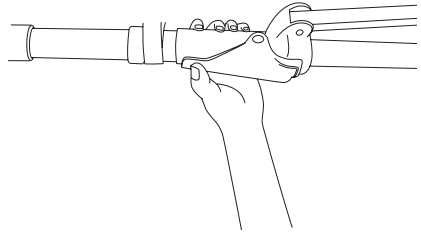

(Fig. 15)

Turn joint knob counter clockwise and turn canopy to an upright vertical position. Turn joint knob clockwise to secure umbrella position (Fig. 16). Loosen bottom pole knob by turning counter clockwise and carefully guide top pole down into bottom pole (Fig. 17). Tighten bottom pole knob by turning clockwise (Fig. 18). Tie 3 canopy ties to secure canopy. Slide protective cover over umbrella (Fig. 19) to protect your umbrella year round.

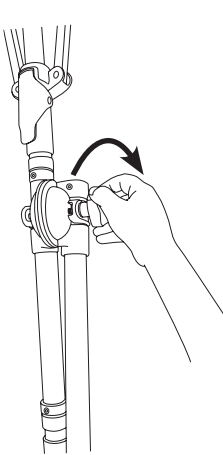

(Fig. 16)

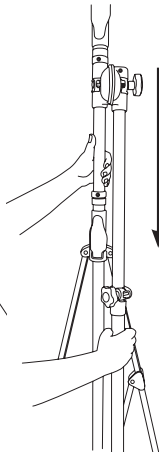

(Fig. 17)

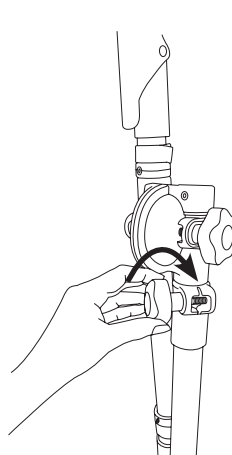

(Fig. 18)

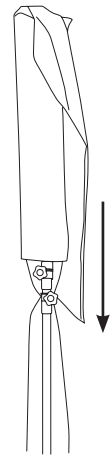

(Fig. 19)

S A F E T Y P R E C A U T I O N S :

- To reduce risk of personal injury in which a person is injured or harmed, and/ or damage to personal property, read and follow the Assembly Guide prior to assembling and operating umbrella and base.
- Close and store the umbrella in windy conditions or when a storm approaches. Never allow the umbrella to flap in the wind; this could cause personal injury, damage to personal property, damage to umbrella and/or umbrella canopy. Do not use tilting function during windy conditions.
- Keep umbrella secured to umbrella base at all times. Base knobs may loosen over time. Simply tighten base knobs during use of umbrella to ensure umbrella is secure.
- Do not leave open umbrella unattended. If damage occurs, this is not covered by the warranty.
- When adjusting the umbrella, make sure that no person(s), item(s) or personal property are close to the umbrella. This is important to prevent injury or material damage.
- Do not allow children to play on or with umbrella or umbrella base.
- When adjusting or assembling the umbrella or umbrella base, make sure fingers, toes or any other parts of the body are clear from moving parts. Failing to do so may result in serious injury.

C A R E A N D M A I N T E N A N C E :

- When not in use, close and cover umbrella with a protective cover.
- Allow a wet canopy to dry while in open position.
- If necessary, clean the fabric with lukewarm water, mild detergent, and a sponge.
- Wipe sliding marks on the aluminum poles with a damp cloth.

Winter Storage:

- Store in a dry, protective place.

After the Winter:

- Check the condition and function of the umbrella. Any defects must be repaired by a professional.

WARRANTY:

The manufacturer warrants that this umbrella, when subject to normal and proper use, will be free from manufacturing defects for a period of one year from the original date of purchase. Should any defect occur during the specified time period, the manufacturer will repair, replace, or provide replacement parts, at its own option. Limited warranty against fabric fading, based on fabric grade. Warranty is not transferable.

We will not warrant any claim coverage unless both the original sales receipt and request form are sent to us. Any items that are returned for warranty or non warranty purposes must be issued a Return Authorization Number. Only

upon issuance of an RA # and inspection by our QC department will credit or replacement of umbrella be issued. It is the customer's responsibility to pay the freight on return products or replacement parts. ALL RETURNED ITEMS MUST INCLUDE THE RA# CLEARLY WRITTEN ON THE RETURN PACKAGE or package will be refused by our warehouse personnel.

NOTE: Damages and failure caused by improper use due to neglect of reasonable and necessary care are not covered by this warranty.

Additionally, acts of nature (including but not limited to wind, hurricanes, tornadoes, and storms) are not covered by this warranty.



www.simplyshade.com

©2021 SimplyShade - All Rights Reserved.

9/21